

Luci SHIN FLEX Indoor / IP65

Illuminance data



LFY7-2 Luci SHIN FLEX 7mm pitch 2.1W/m

Color temperature

6500K 5000K 4000K 3500K 3000K 2700K 2500K 2200K 2000K 1800K

Direct horizontal surface light intensity distribution chart

LFY7-T1000-D-CL_-2

Light source color 6500K
Brightness 109 cd
Luminous flux 337 lm
Color rendering index Ra 95

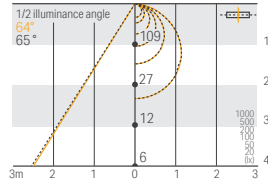

LFY7-T1000-L27-CL_-2

Light source color 2700K
Brightness 109 cd
Luminous flux 298 lm
Color rendering index Ra 93

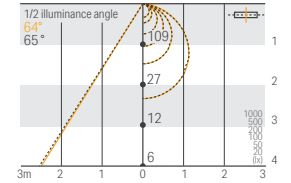

LFY7-T1000-N-CL_-2

Light source color 5000K
Brightness 121 cd
Luminous flux 334 lm
Color rendering index Ra 92

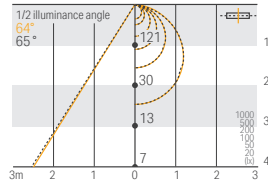

LFY7-T1000-L25-CL_-2

Light source color 2500K
Brightness 75 cd
Luminous flux 221 lm
Color rendering index Ra 93

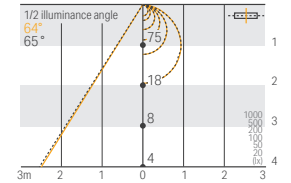

LFY7-T1000-W-CL_-2

Light source color 4000K
Brightness 114 cd
Luminous flux 328 lm
Color rendering index Ra 96

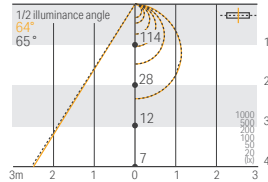

LFY7-T1000-L22-CL_-2

Light source color 2200K
Brightness 71 cd
Luminous flux 206 lm
Color rendering index Ra 92

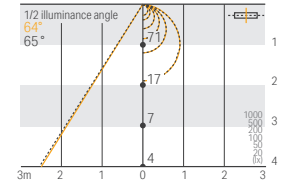

LFY7-T1000-WW-CL_-2

Light source color 3500K
Brightness 126 cd
Luminous flux 325 lm
Color rendering index Ra 96

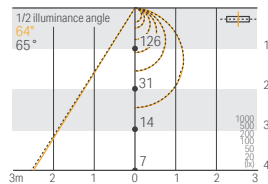

LFY7-T1000-L20-CL_-2

Light source color 2000K
Brightness 58 cd
Luminous flux 188 lm
Color rendering index Ra 90

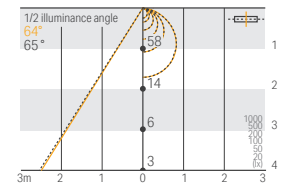

LFY7-T1000-L30-CL_-2

Light source color 3000K
Brightness 123 cd
Luminous flux 316 lm
Color rendering index Ra 94

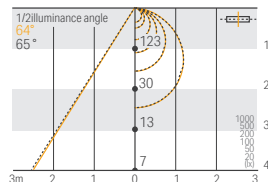

LFY7-T1000-L18-CL_-2

Light source color 1800K
Brightness 66 cd
Luminous flux 182 lm
Color rendering index Ra 90

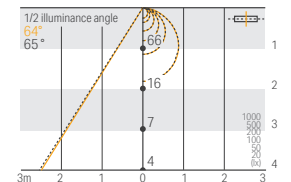

Luminous intensity distribution

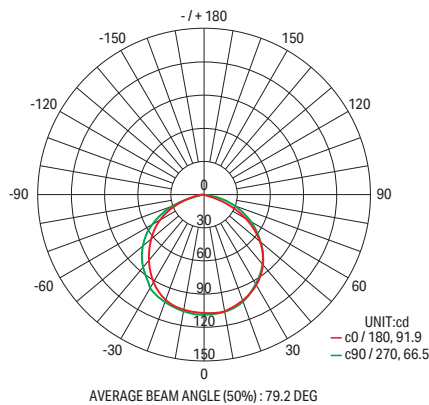

Luci SHIN FLEX Indoor / IP65

Illuminance data



LFY7-4 Luci SHIN FLEX 7mm pitch 4.2W/m

Color temperature

6500K 5000K 4000K 3500K 3000K 2700K 2500K 2200K 2000K 1800K

Direct horizontal surface light intensity distribution chart

LFY7-T1000-D-CL_-4

Light source color 6500K
Brightness 215 cd
Luminous flux 636 lm
Color rendering index Ra 95

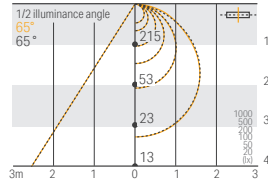

LFY7-T1000-L27-CL_-4

Light source color 2700K
Brightness 215 cd
Luminous flux 563 lm
Color rendering index Ra 93

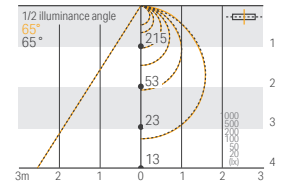

LFY7-T1000-N-CL_-4

Light source color 5000K
Brightness 238 cd
Luminous flux 630 lm
Color rendering index Ra 92

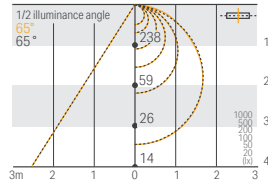

LFY7-T1000-L25-CL_-4

Light source color 2500K
Brightness 148 cd
Luminous flux 417 lm
Color rendering index Ra 93

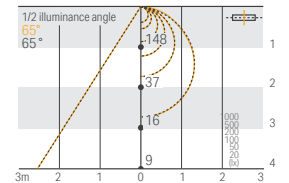

LFY7-T1000-W-CL_-4

Light source color 4000K
Brightness 224 cd
Luminous flux 619 lm
Color rendering index Ra 96

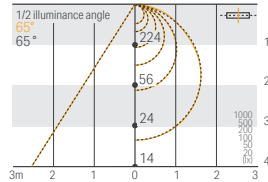

LFY7-T1000-L22-CL_-4

Light source color 2200K
Brightness 140 cd
Luminous flux 388 lm
Color rendering index Ra 92

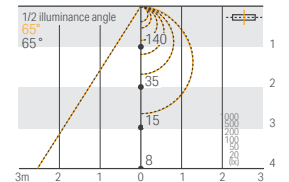

LFY7-T1000-WW-CL_-4

Light source color 3500K
Brightness 248 cd
Luminous flux 614 lm
Color rendering index Ra 96

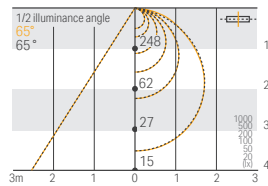

LFY7-T1000-L20-CL_-4

Light source color 2000K
Brightness 115 cd
Luminous flux 355 lm
Color rendering index Ra 90

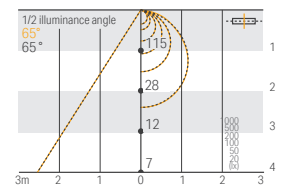

LFY7-T1000-L30-CL_-4

Light source color 3000K
Brightness 242 cd
Luminous flux 597 lm
Color rendering index Ra 94

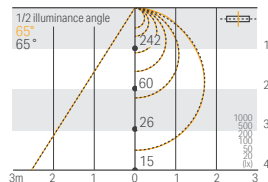

LFY7-T1000-L18-CL_-4

Light source color 1800K
Brightness 131 cd
Luminous flux 343 lm
Color rendering index Ra 90

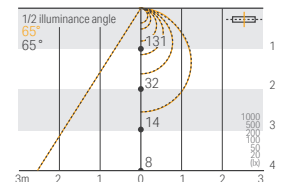

Luminous intensity distribution

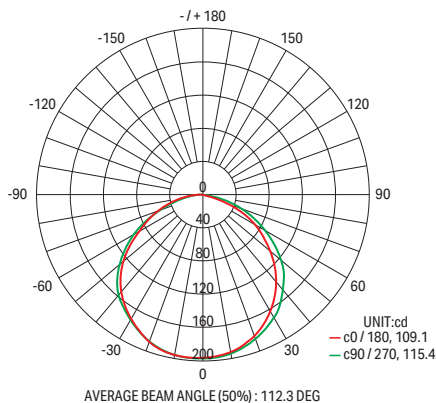

Luci SHIN FLEX Indoor / IP65

Illuminance data



LFY7-6 Luci SHIN FLEX 7mm pitch 6.4W/m

Color temperature

6500K 5000K 4000K 3500K 3000K 2700K 2500K 2200K 2000K 1800K

Direct horizontal surface light intensity distribution chart

LFY7-T1000-D-CL_-6

Light source color 6500K
Brightness 215 cd
Luminous flux 947 lm
Color rendering index Ra 95

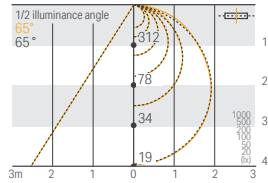

LFY7-T1000-L27-CL_-6

Light source color 2700K
Brightness 215 cd
Luminous flux 838 lm
Color rendering index Ra 93

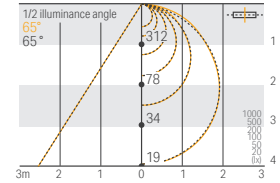

LFY7-T1000-N-CL_-6

Light source color 5000K
Brightness 238 cd
Luminous flux 938 lm
Color rendering index Ra 92

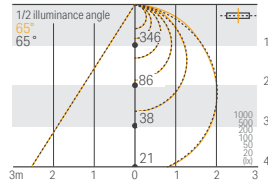

LFY7-T1000-L25-CL_-6

Light source color 2500K
Brightness 148 cd
Luminous flux 620 lm
Color rendering index Ra 93

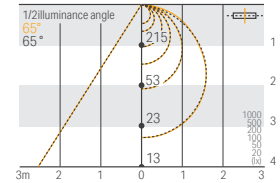

LFY7-T1000-W-CL_-6

Light source color 4000K
Brightness 224 cd
Luminous flux 922 lm
Color rendering index Ra 96

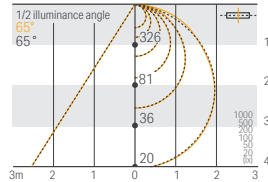

LFY7-T1000-L22-CL_-6

Light source color 2200K
Brightness 140 cd
Luminous flux 578 lm
Color rendering index Ra 92

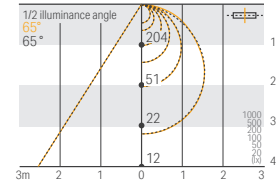

LFY7-T1000-WW-CL_-6

Light source color 3500K
Brightness 248 cd
Luminous flux 913 lm
Color rendering index Ra 96

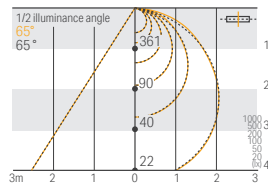

LFY7-T1000-L20-CL_-6

Light source color 2000K
Brightness 115 cd
Luminous flux 528 lm
Color rendering index Ra 90

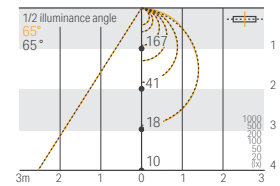

LFY7-T1000-L30-CL_-6

Light source color 3000K
Brightness 242 cd
Luminous flux 888 lm
Color rendering index Ra 94

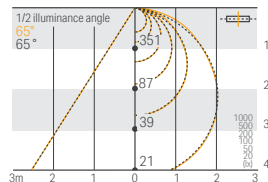

LFY7-T1000-L18-CL_-6

Light source color 1800K
Brightness 190 cd
Luminous flux 511 lm
Color rendering index Ra 90

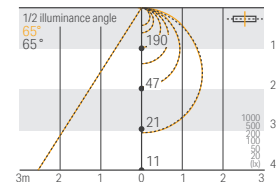

Luminous intensity distribution

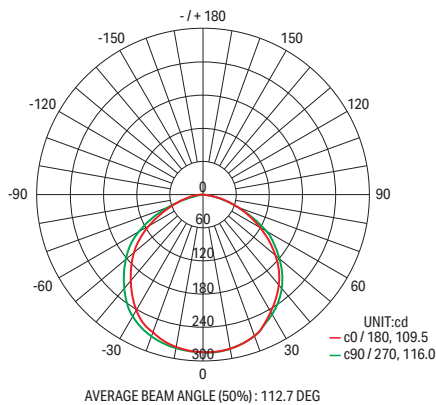

Luci SHIN FLEX Indoor / IP65

Illuminance data



LFY7-10 Luci SHIN FLEX 7mm pitch 10.8W/m

Color temperature

6500K 5000K 4000K 3500K 3000K 2700K 2500K 2200K 2000K 1800K

Direct horizontal surface light intensity distribution chart

LFY7-T1000-D-CL_-10

Light source color 6500K
Brightness 484 cd
Luminous flux 1605 lm
Color rendering index Ra 95

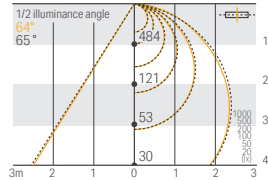

LFY7-T1000-L27-CL_-10

Light source color 2700K
Brightness 484 cd
Luminous flux 1421 lm
Color rendering index Ra 93

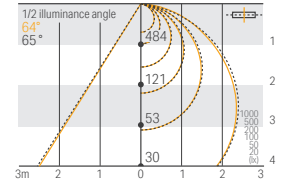

LFY7-T1000-N-CL_-10

Light source color 5000K
Brightness 537 cd
Luminous flux 1591 lm
Color rendering index Ra 92

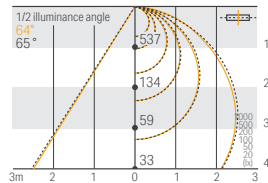

LFY7-T1000-L25-CL_-10

Light source color 2500K
Brightness 334 cd
Luminous flux 1051 lm
Color rendering index Ra 93

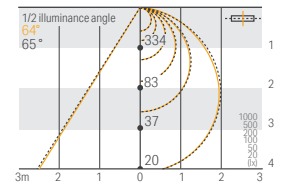

LFY7-T1000-W-CL_-10

Light source color 4000K
Brightness 505 cd
Luminous flux 1563 lm
Color rendering index Ra 96

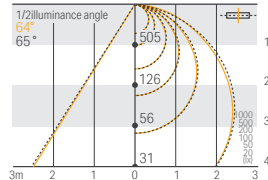

LFY7-T1000-L22-CL_-10

Light source color 2200K
Brightness 316 cd
Luminous flux 980 lm
Color rendering index Ra 92

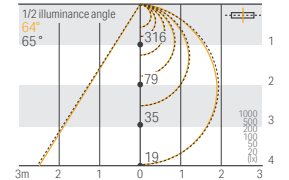

LFY7-T1000-WW-CL_-10

Light source color 3500K
Brightness 559 cd
Luminous flux 1548 lm
Color rendering index Ra 96

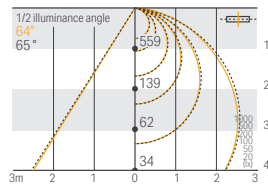

LFY7-T1000-L20-CL_-10

Light source color 2000K
Brightness 260 cd
Luminous flux 895 lm
Color rendering index Ra 90

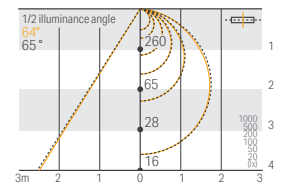

LFY7-T1000-L30-CL_-10

Light source color 3000K
Brightness 531 cd
Luminous flux 1506 lm
Color rendering index Ra 94

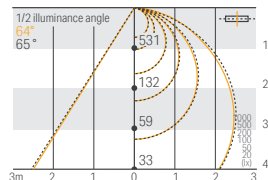

LFY7-T1000-L18-CL_-10

Light source color 1800K
Brightness 295 cd
Luminous flux 867 lm
Color rendering index Ra 90

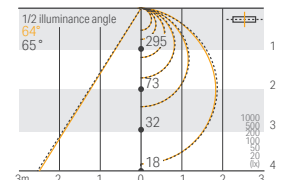

Luminous intensity distribution

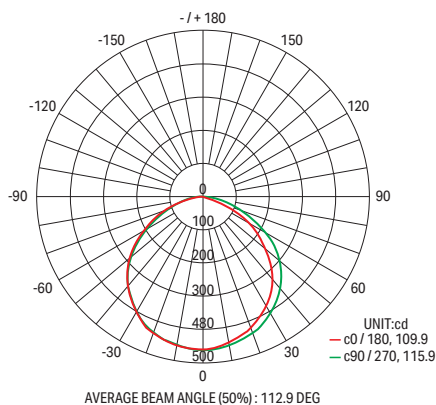

Luci SHIN FLEX Indoor / IP65

Illuminance data



LFY7-15 Luci SHIN FLEX 7mm pitch 15.9W/m

Color temperature

6500K 5000K 4000K 3500K 3000K 2700K 2500K 2200K 2000K 1800K

Direct horizontal surface light intensity distribution chart

LFY7-T1000-D-CL_-15

Light source color 6500K
Brightness 676 cd
Luminous flux 2260 lm
Color rendering index Ra 95

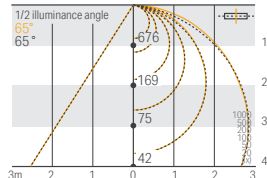

LFY7-T1000-N-CL_-15

Light source color 5000K
Brightness 750 cd
Luminous flux 2240 lm
Color rendering index Ra 92

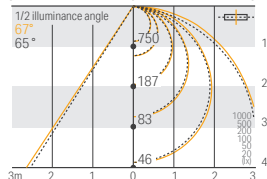

LFY7-T1000-W-CL_-15

Light source color 4000K
Brightness 707 cd
Luminous flux 2200 lm
Color rendering index Ra 96

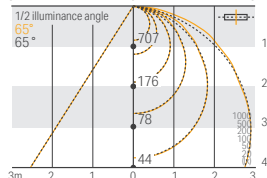

LFY7-T1000-WW-CL_-15

Light source color 3500K
Brightness 774 cd
Luminous flux 2180 lm
Color rendering index Ra 96

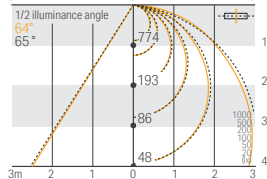

LFY7-T1000-L30-CL_-15

Light source color 3000K
Brightness 761 cd
Luminous flux 2120 lm
Color rendering index Ra 94

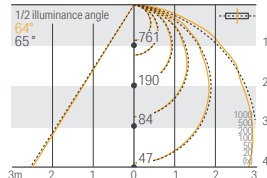

LFY7-T1000-L27-CL_-15

Light source color 2700K
Brightness 677 cd
Luminous flux 2000 lm
Color rendering index Ra 93

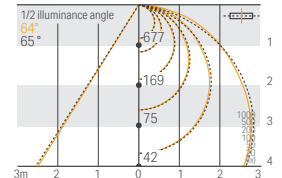

LFY7-T1000-L25-CL_-15

Light source color 2500K
Brightness 468 cd
Luminous flux 1480 lm
Color rendering index Ra 93

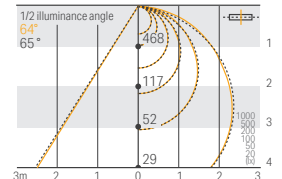

LFY7-T1000-L22-CL_-15

Light source color 2200K
Brightness 441 cd
Luminous flux 1380 lm
Color rendering index Ra 92

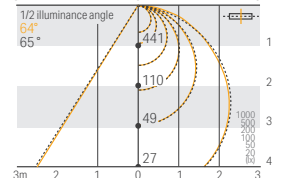

LFY7-T1000-L20-CL_-15

Light source color 2000K
Brightness 357 cd
Luminous flux 1260 lm
Color rendering index Ra 90

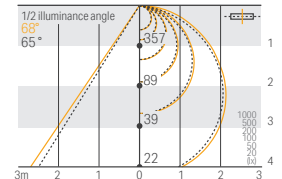

LFY7-T1000-L18-CL_-15

Light source color 1800K
Brightness 346 cd
Luminous flux 1220 lm
Color rendering index Ra 90

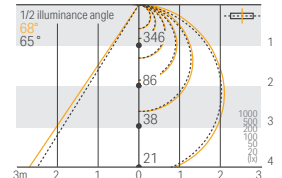

Luminous intensity distribution

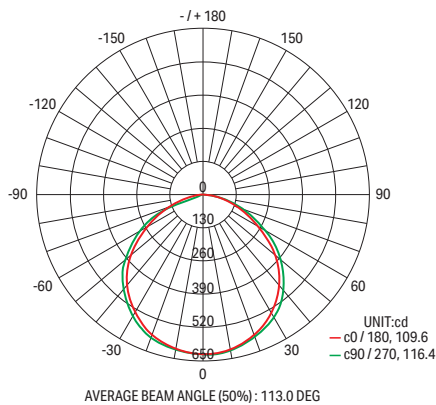

Luci SHIN FLEX Indoor / IP65

Illuminance data



LFY18-2 Luci SHIN FLEX 18mm pitch 2.9W/m

Color temperature

6500K 5000K 4000K 3500K 3000K 2700K 2500K 2200K 2000K 1800K

Direct horizontal surface light intensity distribution chart

LFY18-T1000-D-CL_-2

Light source color 6500K
Brightness 158cd
Luminous flux 447 lm
Color rendering index Ra 95

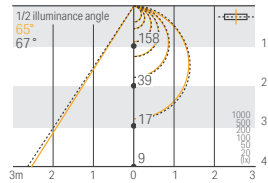

LFY18-T1000-L27-CL_-2

Light source color 2700K
Brightness 677 cd
Luminous flux 396 lm
Color rendering index Ra 93

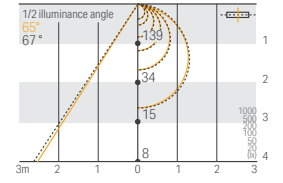

LFY18-T1000-N-CL_-2

Light source color 5000K
Brightness 154 cd
Luminous flux 443 lm
Color rendering index Ra 92

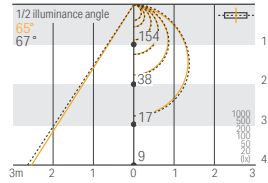

LFY18-T1000-L25-CL_-2

Light source color 2500K
Brightness 102 cd
Luminous flux 293 lm
Color rendering index Ra 93

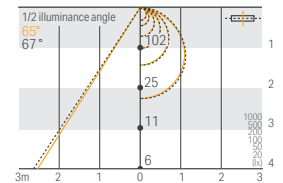

LFY18-T1000-W-CL_-2

Light source color 4000K
Brightness 152 cd
Luminous flux 435 lm
Color rendering index Ra 96

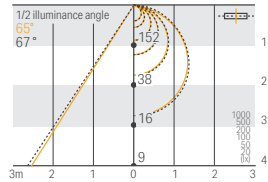

LFY18-T1000-L22-CL_-2

Light source color 2200K
Brightness 95 cd
Luminous flux 273 lm
Color rendering index Ra 92

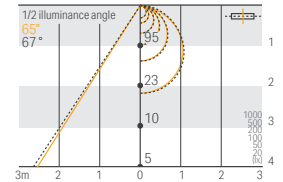

LFY18-T1000-WW-CL_-2

Light source color 3500K
Brightness 150 cd
Luminous flux 431 lm
Color rendering index Ra 96

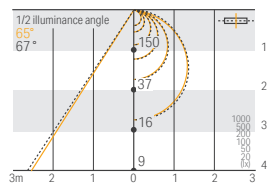

LFY18-T1000-L20-CL_-2

Light source color 2000K
Brightness 87 cd
Luminous flux 249 lm
Color rendering index Ra 90

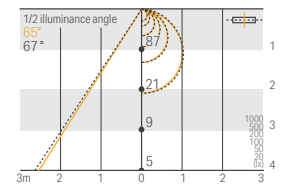

LFY18-T1000-L30-CL_-2

Light source color 3000K
Brightness 146 cd
Luminous flux 419 lm
Color rendering index Ra 94

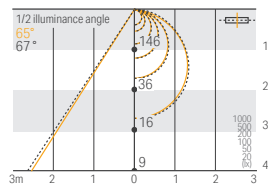

LFY18-T1000-L18-CL_-2

Light source color 1800K
Brightness 85 cd
Luminous flux 229 lm
Color rendering index Ra 90

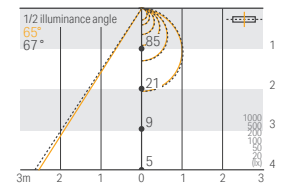

Luminous intensity distribution

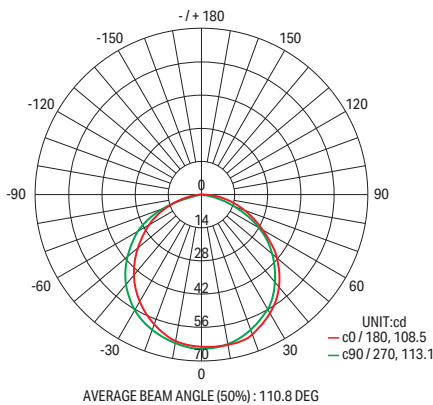

Luci SHIN FLEX Indoor / IP65

Illuminance data



LFY18-4 Luci SHIN FLEX 18mm pitch 4.9W/m

Color temperature

6500K 5000K 4000K 3500K 3000K 2700K 2500K 2200K 2000K 1800K

Direct horizontal surface light intensity distribution chart

LFY18-T1000-D-CL_-4

Light source color 6500K
Brightness 246 cd
Luminous flux 753 lm
Color rendering index Ra 95

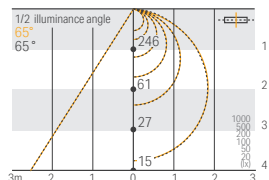

LFY18-T1000-L27-CL_-4

Light source color 2700K
Brightness 246 cd
Luminous flux 666 lm
Color rendering index Ra 93

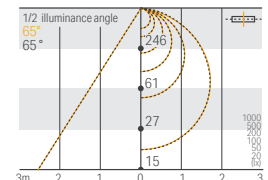

LFY18-T1000-N-CL_-4

Light source color 5000K
Brightness 275 cd
Luminous flux 746 lm
Color rendering index Ra 92

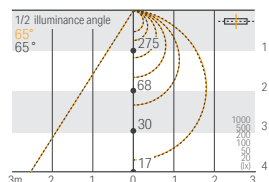

LFY18-T1000-L25-CL_-4

Light source color 2500K
Brightness 182 cd
Luminous flux 493 lm
Color rendering index Ra 93

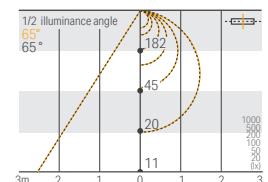

LFY18-T1000-W-CL_-4

Light source color 4000K
Brightness 270 cd
Luminous flux 733 lm
Color rendering index Ra 96

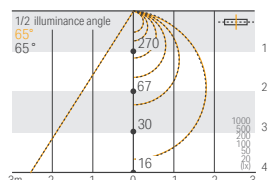

LFY18-T1000-L22-CL_-4

Light source color 2200K
Brightness 169 cd
Luminous flux 460 lm
Color rendering index Ra 92

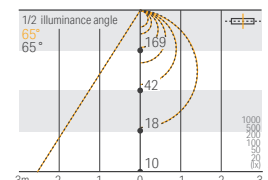

LFY18-T1000-WW-CL_-4

Light source color 3500K
Brightness 268cd
Luminous flux 726 lm
Color rendering index Ra 96

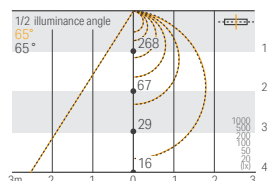

LFY18-T1000-L20-CL_-4

Light source color 2000K
Brightness 155 cd
Luminous flux 420 lm
Color rendering index Ra 90

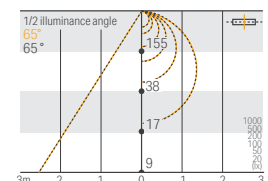

LFY18-T1000-L30-CL_-4

Light source color 3000K
Brightness 761 cd
Luminous flux 706 lm
Color rendering index Ra 94

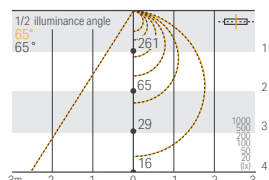

LFY18-T1000-L18-CL_-4

Light source color 1800K
Brightness 150 cd
Luminous flux 381 lm
Color rendering index Ra 90

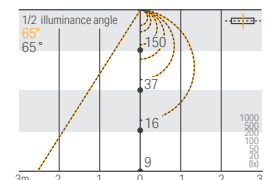

Luminous intensity distribution

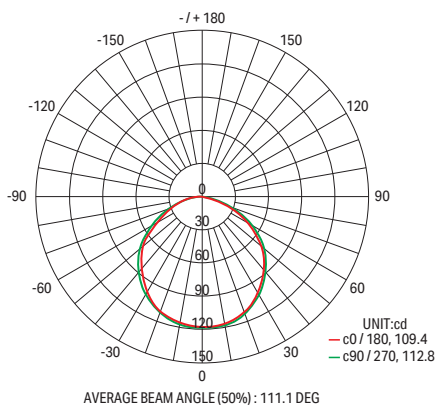

Luci SHIN FLEX Indoor / IP65

Illuminance data



LFY18-6 Luci SHIN FLEX 18mm pitch 6.9W/m

Color temperature

6500K 5000K 4000K 3500K 3000K 2700K 2500K 2200K 2000K 1800K

Direct horizontal surface light intensity distribution chart

LFY18-T1000-D-CL_-6

Light source color 6500K
Brightness 373 cd
Luminous flux 1075 lm
Color rendering index Ra 95

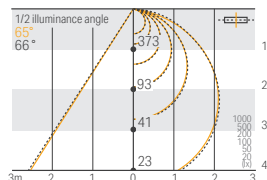

LFY18-T1000-L27-CL_-6

Light source color 2700K
Brightness 325 cd
Luminous flux 951 lm
Color rendering index Ra 93

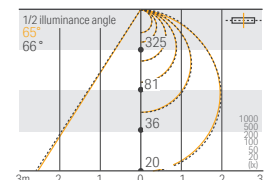

LFY18-T1000-N-CL_-6

Light source color 5000K
Brightness 363 cd
Luminous flux 1066 lm
Color rendering index Ra 92

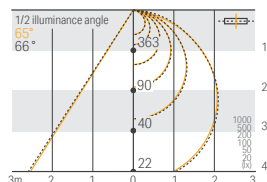

LFY18-T1000-L25-CL_-6

Light source color 2500K
Brightness 240 cd
Luminous flux 704 lm
Color rendering index Ra 93

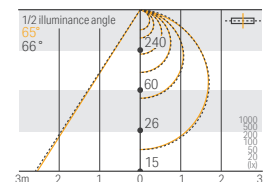

LFY18-T1000-W-CL_-6

Light source color 4000K
Brightness 357 cd
Luminous flux 1047 lm
Color rendering index Ra 96

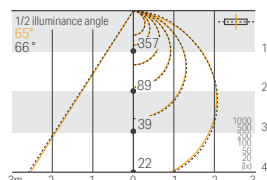

LFY18-T1000-L22-CL_-6

Light source color 2200K
Brightness 223 cd
Luminous flux 657 lm
Color rendering index Ra 92

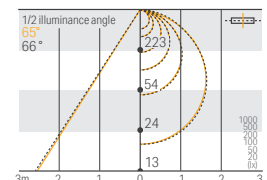

LFY18-T1000-WW-CL_-6

Light source color 3500K
Brightness 353 cd
Luminous flux 1037 lm
Color rendering index Ra 96

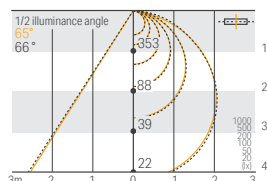

LFY18-T1000-L20-CL_-6

Light source color 2000K
Brightness 204 cd
Luminous flux 599 lm
Color rendering index Ra 90

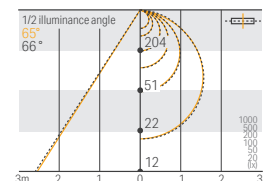

LFY18-T1000-L30-CL_-6

Light source color 3000K
Brightness 344 cd
Luminous flux 1009 lm
Color rendering index Ra 94

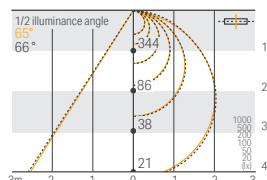

LFY18-T1000-L18-CL_-6

Light source color 1800K
Brightness 198 cd
Luminous flux 526 lm
Color rendering index Ra 90

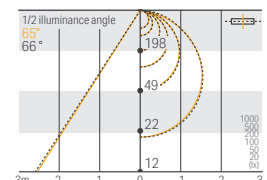

Luminous intensity distribution

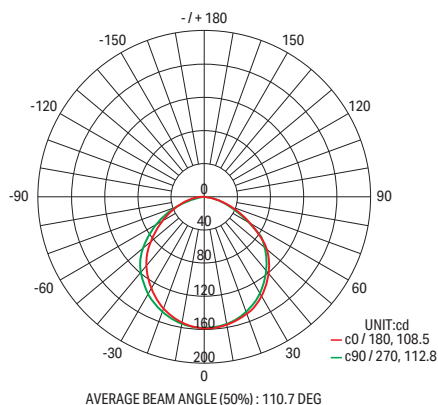

Luci SHIN FLEX Indoor / IP65

Illuminance data



LFY18-10 Luci SHIN FLEX 18mm pitch 10.8W/m

Color temperature

6500K 5000K 4000K 3500K 3000K 2700K 2500K 2200K 2000K 1800K

Direct horizontal surface light intensity distribution chart

LFY18-T1000-D-CL_-10

Light source color 6500K
Brightness 517 cd
Luminous flux 1695 lm
Color rendering index Ra 95

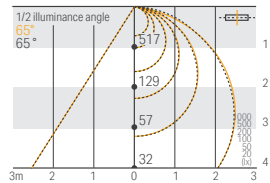

LFY18-T1000-L27-CL_-10

Light source color 2700K
Brightness 450 cd
Luminous flux 1500 lm
Color rendering index Ra 93

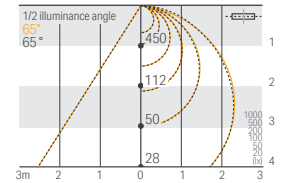

LFY18-T1000-N-CL_-10

Light source color 5000K
Brightness 504 cd
Luminous flux 1680 lm
Color rendering index Ra 92

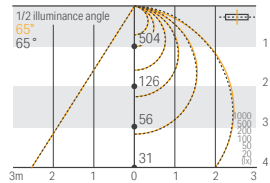

LFY18-T1000-L25-CL_-10

Light source color 2500K
Brightness 333 cd
Luminous flux 1110 lm
Color rendering index Ra 93

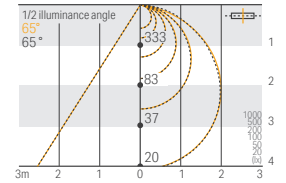

LFY18-T1000-W-CL_-10

Light source color 4000K
Brightness 495 cd
Luminous flux 1650 lm
Color rendering index Ra 96

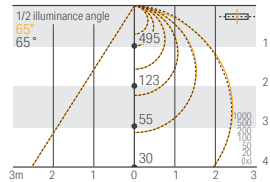

LFY18-T1000-L22-CL_-10

Light source color 2200K
Brightness 310 cd
Luminous flux 1035 lm
Color rendering index Ra 92

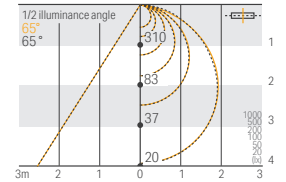

LFY18-T1000-WW-CL_-10

Light source color 3500K
Brightness 490 cd
Luminous flux 1635 lm
Color rendering index Ra 96

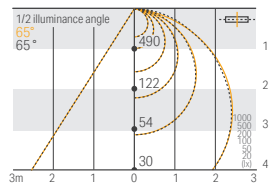

LFY18-T1000-L20-CL_-10

Light source color 2000K
Brightness 283 cd
Luminous flux 945 lm
Color rendering index Ra 90

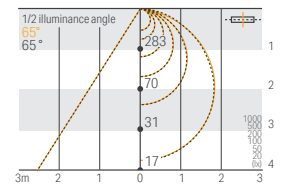

LFY18-T1000-L30-CL_-10

Light source color 3000K
Brightness 477 cd
Luminous flux 1590 lm
Color rendering index Ra 94

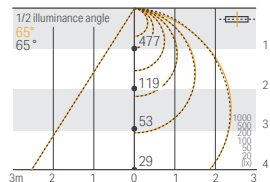

LFY18-T1000-L18-CL_-10

Light source color 1800K
Brightness 271 cd
Luminous flux 795 lm
Color rendering index Ra 90

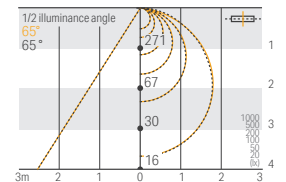

Luminous intensity distribution

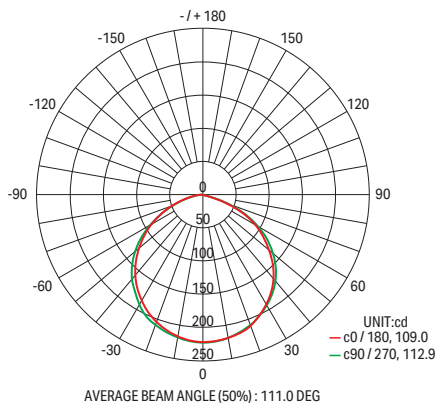

Luci SHIN FLEX Indoor / IP65

Illuminance data



LFY18-12 Luci SHIN FLEX 18mm pitch 12.7W/m

Color temperature

6500K 5000K 4000K 3500K 3000K 2700K 2500K 2200K 2000K 1800K

Direct horizontal surface light intensity distribution chart

LFY18-T1000-D-CL_-12

Light source color 6500K
Brightness 589 cd
Luminous flux 1992 lm
Color rendering index Ra 95

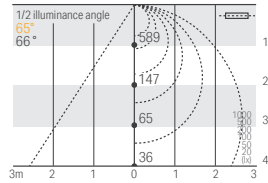

LFY18-T1000-L27-CL_-12

Light source color 2700K
Brightness 512 cd
Luminous flux 1763 lm
Color rendering index Ra 93

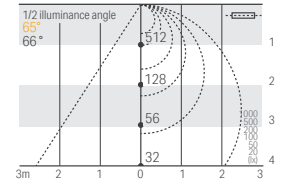

LFY18-T1000-N-CL_-12

Light source color 5000K
Brightness 512 cd
Luminous flux 1974 lm
Color rendering index Ra 92

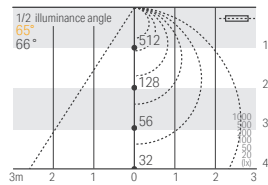

LFY18-T1000-L25-CL_-12

Light source color 2500K
Brightness 379 cd
Luminous flux 1304 lm
Color rendering index Ra 93

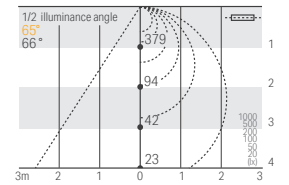

LFY18-T1000-W-CL_-12

Light source color 4000K
Brightness 564 cd
Luminous flux 1939 lm
Color rendering index Ra 96

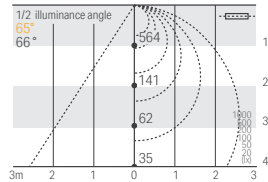

LFY18-T1000-L22-CL_-12

Light source color 2200K
Brightness 353 cd
Luminous flux 1216 lm
Color rendering index Ra 92

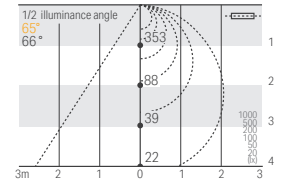

LFY18-T1000-WW-CL_-12

Light source color 3500K
Brightness 512 cd
Luminous flux 1921 lm
Color rendering index Ra 96

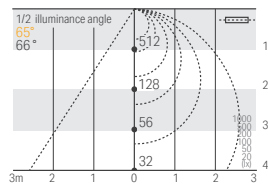

LFY18-T1000-L20-CL_-12

Light source color 2000K
Brightness 323 cd
Luminous flux 1111 lm
Color rendering index Ra 90

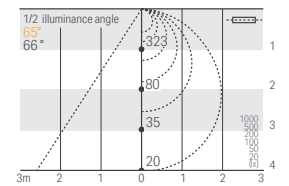

LFY18-T1000-L30-CL_-12

Light source color 3000K
Brightness 543 cd
Luminous flux 1868 lm
Color rendering index Ra 94

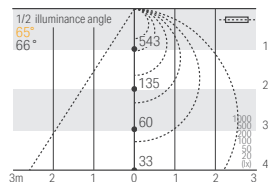

LFY18-T1000-L18-CL_-12

Light source color 1800K
Brightness 312 cd
Luminous flux 911 lm
Color rendering index Ra 90

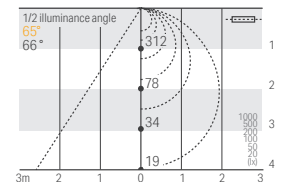

Luminous intensity distribution

